

POLANIK
Poland, Życzliwa 11
97-300 Piotrków Trybunalski

tel. +48 44 646 44 81
tel. +48 44 648 50 89
fax +48 44 646 43 58

e-mail: info@polanik.com
www.polanik.com



TECHNICAL SPECIFICATION **ASSEMBLY MANUAL**

**Pole vault school multicube
landing area**

T-547



File: 2014-07-21

PRODUCT SUPPORT

Paweł Ciechanowski

p.ciechanowski@polanik.com

Thank you for choosing POLANIK landing area.

Safe assembly and use



- **ATTENTION! VACCUUM PACKED PRODUCT – UNPACK IMMEDIATELY AFTER DELIVERY**
- Before you start to assemble and use the landing area please read this manual carefully and store the manual in a safe place for further reference. Polanik Sp. z o. o. shall not be liable for any cage damages which are the result of the failure to follow this manual.
- Unauthorized copying of this manual, in whole or in part, is prohibited.
- The contents of this manual are subject to change without notice.
- Warning! The sports equipment produced by Polanik Sp. z o. o. is designed for athletics training and use in sports competitions only. Please pay special attention when using the product, misuse of athletics equipment can cause serious injury or in extreme cases even death. That is why training and use during sports events have to be always supervised by authorized sports personnel. In no event shall Polanik Sp. z o. o. be liable for any special, incidental, indirect or consequential damages in connection with the purchase or use of POLANIK products or costs over the original cost of the product.
- Specific warranty terms:
 - 1) The use of the landing area outdoors requires a waterproof cover and a landing area platform for proper insulation from the ground. Failure to follow the above restrictions results in the loss of the warranty rights.
 - 2) The top pad of the landing area is equipped with a spike resistant mesh fabric. The mesh fabric is designed to protect the landing area against spikes used by jumpers. While landing and walking on the top pad the spikes go through the mesh fabric and do not damage the surface. One must not shuffle the spikes on the mesh fabric, because under high crosswise stress caused by moving the spikes without lifting the feet, it may happen that the top pad will be torn. The damages of the top pad caused by careless sliding the pikes on the top pad surface are excluded from the warranty and can be removed in course of payable repair or replacement of the landing area elements.

Contents

Chapter	Page
I. General description	3
II. Technical specification	3
III. Packing and transport	5
IV. Preparing for first use	5
V. Assembly	6
VI. Operation	6
VII. Maintenance	6
VIII. Storing	6
IX. Declaration	7

I. General description

POLANIK landing area T-547 is top quality sports equipment which is designed to secure jumpers and absorb impact energy of a jumper`s landing after take off and flight in pole vault training. Main features:

stainless steel hooks and D-rings	advanced 3-layer internal construction	jacquard webbing belts equipped with metal self-locking buckles	handles made of very strong jacquard webbing	outer covering – PVC fabric made of polyester with two vinyl layers
				

II. Technical specification

Code	T-547
Type	school, pole vault, complies to EN 12503-2 type 11
Dimensions length / width / height [m]	5 / 4 / 0,7
Gross weight [kg]	kg
Number of elements [pcs]	7
Segment description	1 pole vault front panel left 2 pole vault front panel right 3 main segment left 4 main segment right 5 top pad
Spike resistant surface	upper surface of top pad is equipped with spike resistant mesh fabric
Segment covering	PVC, made of polyester with two vinyl layers, mash fabric venting sides and tops
Internal structure	advanced 3-layer construction, chamber system, made of high quality PUR foam
Way of top pad linking	stainless steel hooks and D-rings
Way of waterproof cover linking	metal D-rings
Carrying handles	very strong jacquard webbing, firmly attached by means of envelope stitching

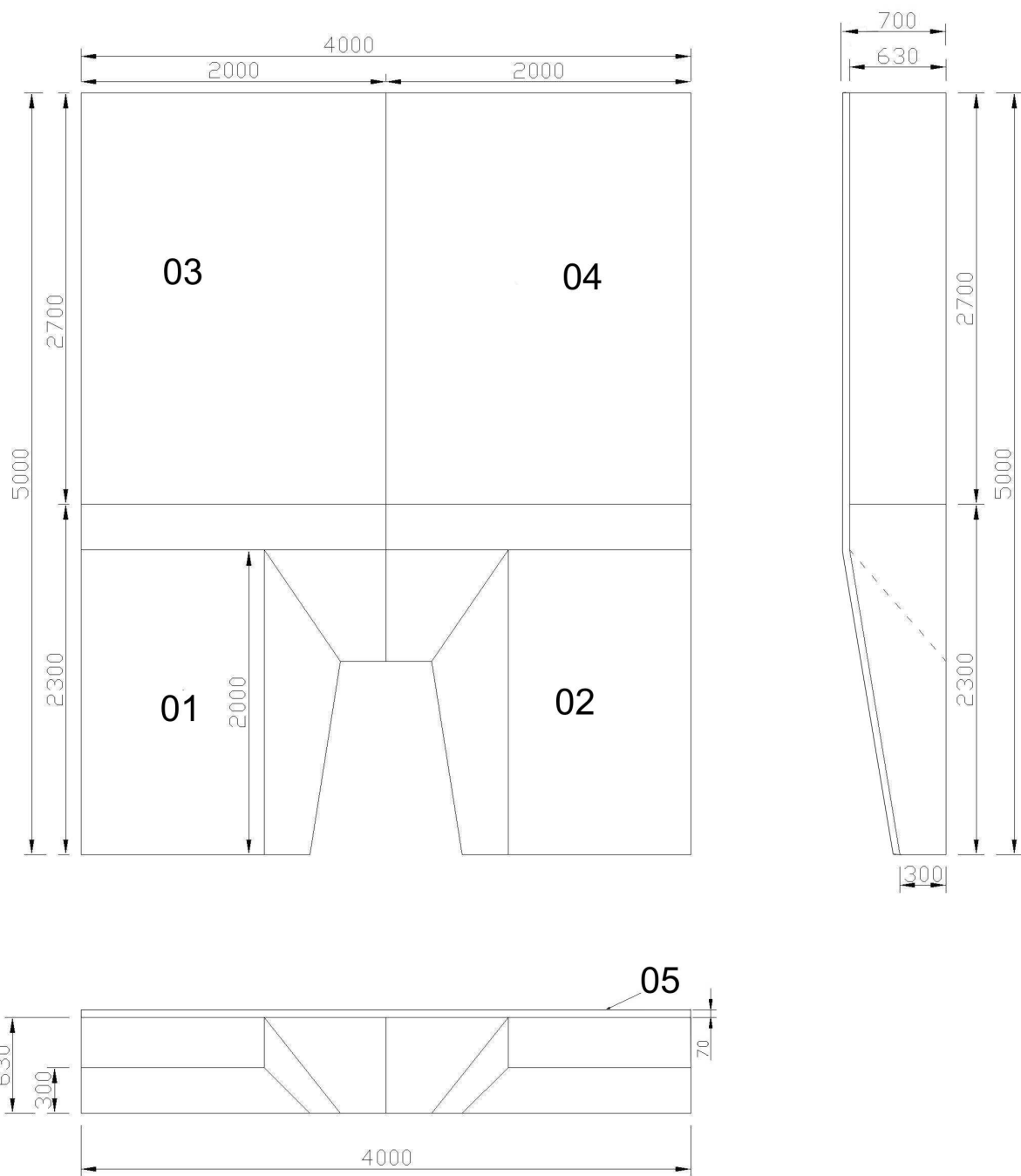

All dimensions [mm]

III. Packing and transport

Each element is vacuum packed in foil:

	element no.	01	02	03	04	05	
Packages' dimensions* [m]	length L	2,1	2,1	2	2	2,17	total
	width B	0,85	0,85	0,85	0,85	0,85	
	height H	0,85	0,85	0,85	0,85	0,85	
Volume [m ³]		1,52	1,52	1,45	1,45	1,57	7,51
Gross weight [kg]		85	85	88	88	80	426

*Please note that the dimensions can differ from the above table in the range of +/- 7%.

IV. Preparing for first use

The landing area elements are vacuum packed only for transport. Please unpack them immediately after delivery and leave them in a roofed place for few hours, so that they can return to their original shapes. **Storing vacuum packed landing area elements may cause permanent damages in their internal structures.** When the landing area elements return to their original dimensions, you can place them in a pole vault field. The field surface should be even, smooth and without any obstacles. If you use the landing area outdoors, you should also provide: a special waterproof cover P-547 to protect the landing area against unfavourable weather conditions and a modular platform ST-5x4 to insulate the landing area from the ground.

V. Assembly

It is done in the following way:

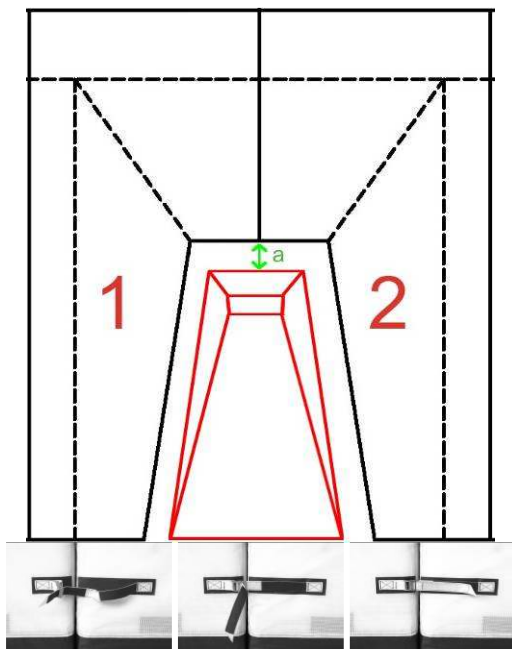

place the pole vault front panels (01 and 02 see the drawing on page 4) around the pole vault box, so as the distance between the rear edge of the box and the landing area pads (a) is 15 cm, make sure that all the Velcro® pads adjoin properly. Next main segments 03 and 04 should be linked together

using the jacquard webbing belts and self-locking buckles located on the segment sides,

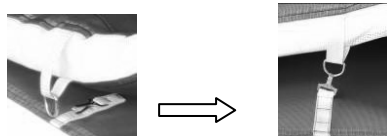

last step is to place the top pad 05 on the landing area and fasten it to the segments using the snap hooks and D-rings, now the landing area is ready for use.

VI. Operation

Stepping on the landing area and practising require special footwear designed for those purposes. Treading on the landing area in footwear with spikes is only allowed when the landing area is equipped with special spike resistant surface. Stepping on the landing areas in hard footwear or in shoes with heels is strongly prohibited. You must not put any tables, chairs, benches or any other objects whose unit pressure exceeds $1\text{kg}/1\text{cm}^2$ on the landing area. If the landing area is moved from one place to another very often, it is recommended that a landing area cart should be used.

VII. Maintenance

Due to the hygiene requirements it is recommended that the landing area should be cleaned regularly with commonly available detergents. Before you start wiping the landing area, please try to clean a small spot on its bottom side in order to check the reaction with the PVC fabric.

VIII. Storing

The landing area segments can be stored only in a horizontal position. They cannot be bent or pressed by any objects during storing. That may deform the segments permanently. A storing facility should be clean and dry. It ought to provide min. temperature $5\text{ }^\circ\text{C}$.

Even the best technical solutions cannot substitute for common sense. The usage of the product must take place under the supervision of qualified coaches. The producer shall not be liable for any incidents caused by the improper assembly or its misuse. The producer reserves the right to introduce without warning changes in product constructions and colours.

IX. Declaration

- 1) No.2013-06-21
- 2) Issuer's name: POLANIK Sp. z o. o.
Issuer's address: Życzliwa 11, 97-300 Piotrków Tryb.
- 3) Object of declaration

No.	Name	Code
1	School multicube landing area 5 x 4 x 0,7 m	T-547

- 4) The object of declaration described above is in conformity with requirements of the following document:

Document No.	Title	Edition/Date of issue	Position
PN-EN 12503-2	Sports mats – Part 2: Pole vault and high jump mats, safety requirements	April 2004	All above

Additional Information

- 5) Declaration for:

Buyer and User

Signed for and in behalf of:

POLANIK

2014-07-21 Piotrków Tryb.

(Date and place of issue)

Paweł Ciechanowski
Product Manager

- 6)

(Name, function)



.....

(Signature or its equivalent authorized by the issuer)